

CI/SIB	(29)	E16	
February 2008			

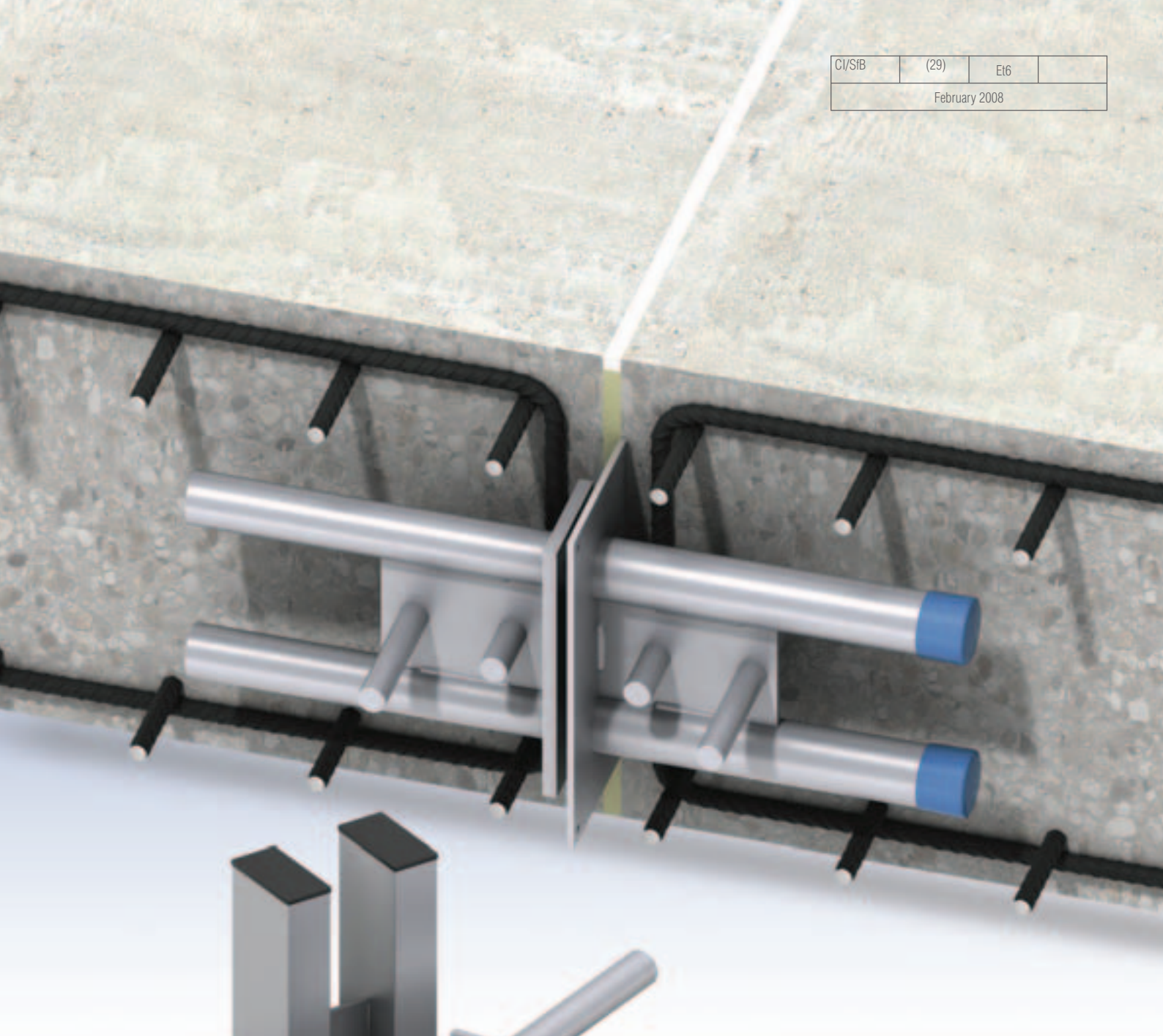

DSD/Q  
**Design  
Program**  
Available

## Shear Load Connectors

for the Construction Industry

**Ancon**<sup>®</sup>  
BUILDING PRODUCTS

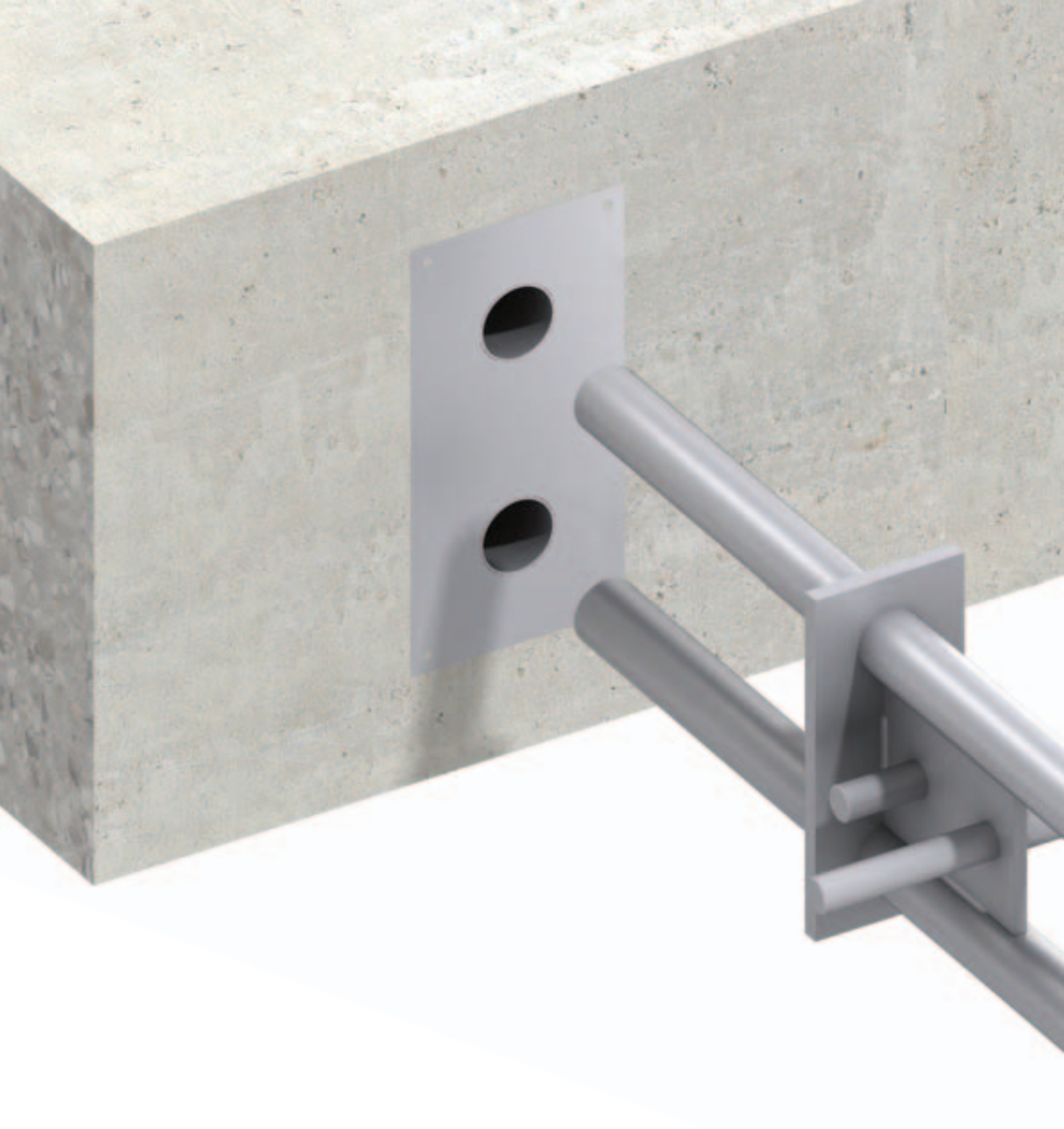

**Ancon designs and manufactures high integrity steel products for the construction industry. Through continuous programmes of new product development, inward investment and employee advancement, the company is committed to maintaining the highest level of customer service within a dynamic and challenging industry.**

Reinforced concrete is an important construction material. It offers strength, durability and can be formed into a variety of shapes. Concrete structures are designed with expansion and contraction joints at appropriate places to allow movement to take place. The design of the joint is important for the overall design to function correctly.

Ancon shear load connectors offer significant advantages over plain dowels.

Masonry Support Systems	Dowelled & Keyed Joints	4
Masonry Reinforcement	Ancon Solutions to Joints	5
Windposts and Lintels	Ancon Shear Connector Range	6-7
Wall Ties and Restraint Fixings	Installation Procedure	8
Channel and Bolt Fixings	Design Capacities	9
Tension Systems	DSD and DSDQ Connectors	10-14
Stainless Steel Fabrications	ESD, ESDQ, ED	
Flooring and Formed Sections	and Acoustic Connectors	15-18
<b>Shear Load Connectors</b>	Applications	19
Reinforcing Bar Couplers	Other Ancon Products	19
Reinforcement Continuity Systems		
Punching Shear Reinforcement		
Insulated Balcony Connectors		
Refractory Fixings		



BS EN ISO 9001: 2000  
FM12226



ISO 14001: 2004  
EMS 505377





# Shear Load Connectors

## DOWELLED JOINTS

Dowels are used to transfer shear across construction and movement joints in concrete. They are often either cast or drilled into the concrete. A single row of short thick dowels provides reasonable shear transfer but suffers from deformation. This can lead to stress concentrations, resulting in subsequent spalling of the concrete.

Where dowels are used across expansion and contraction joints, half the length of the bar is debonded to allow movement to take place.

Dowelled joints either require formwork to be drilled for the dowels to pass through, or concrete to be drilled for dowels to be resin fixed in one side.

At movement joints, dowels will need to be accurately aligned in both directions to ensure movement can actually take place, otherwise cracking is likely to occur.

Plain dowels are not very effective when used across joints wider than 10mm.

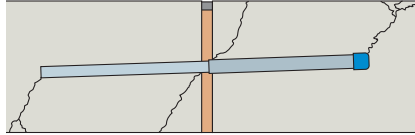

## KEYED JOINTS

Keyed joints require complicated formwork to create the tongue and groove. If the joint is not formed correctly, differential movement can take place. Load is transferred through the locally reduced section of the joint which can at times result in cracking.

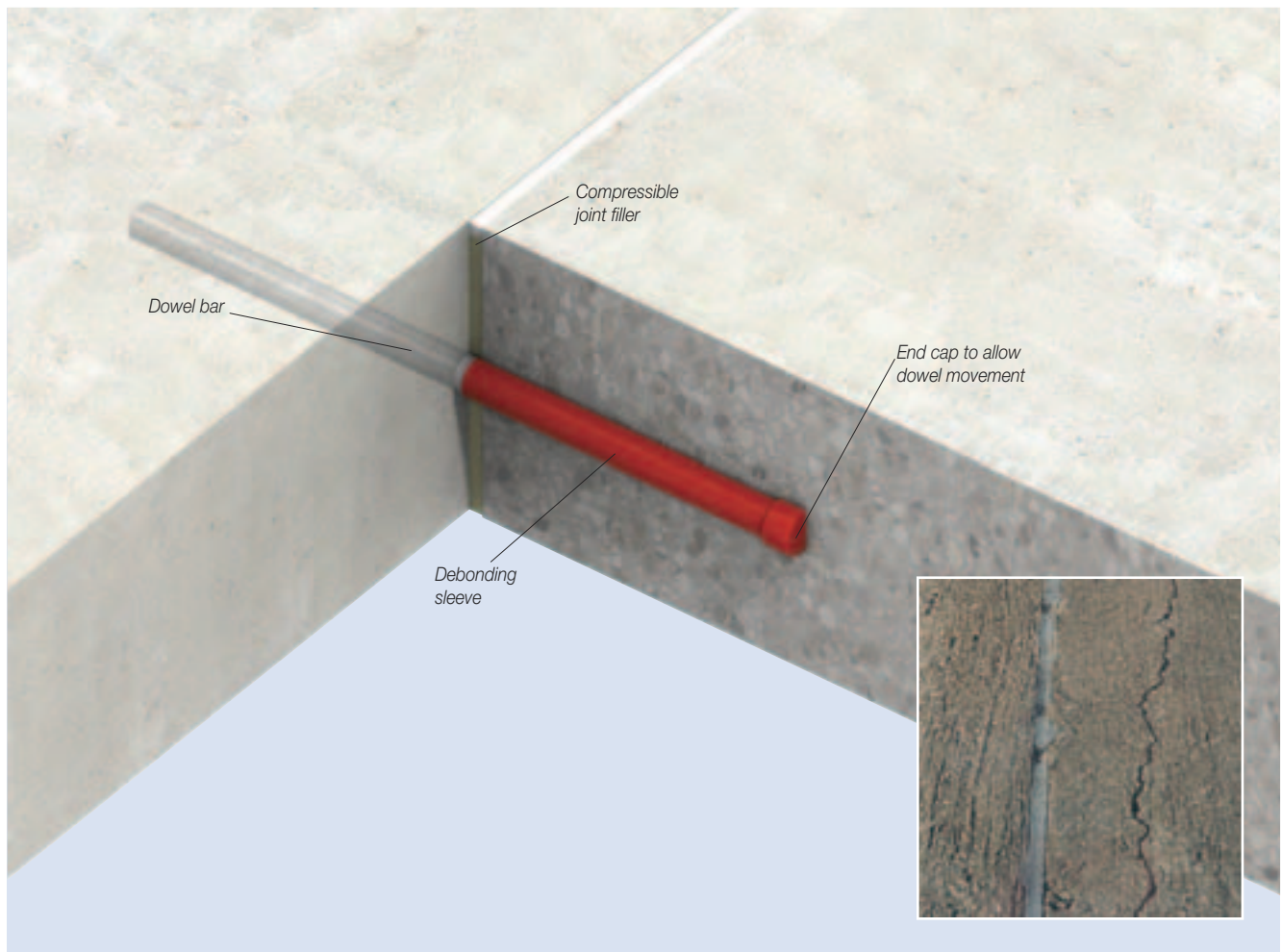
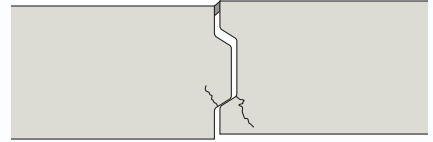

Misaligned dowels can result in cracking away from the expansion joint

Ancon DSD sleeve

Ancon DSD  
dowel component

The two-part assembly of Ancon connectors ensures dowel alignment

**Conventional Joints**  
**Floor Slab**

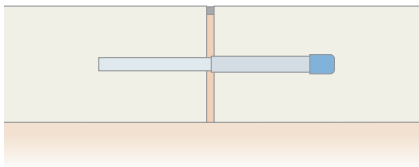

Dowel Bar

**Ancon Solutions**

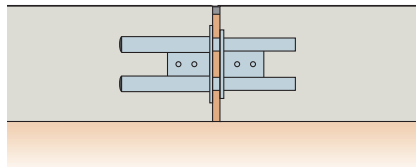

Ancon DSD

**Wall**

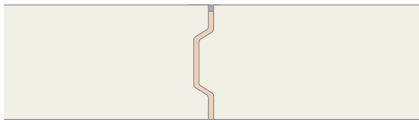

Keyed Joint

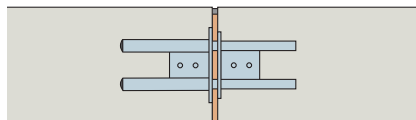

Ancon DSD

**Structural Movement Joint**

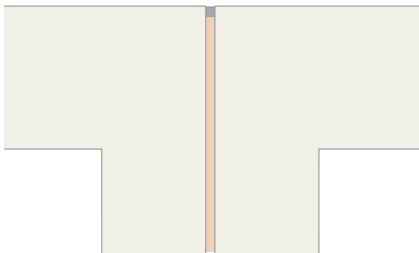

Double Columns

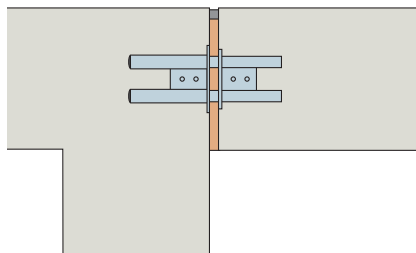

Ancon DSD

**Floor to Wall Connection**

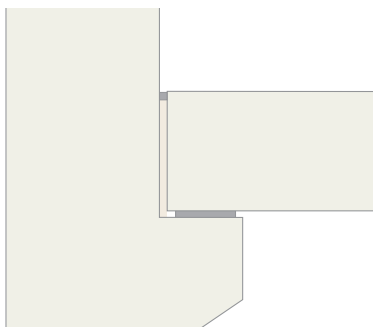

Corbel Support

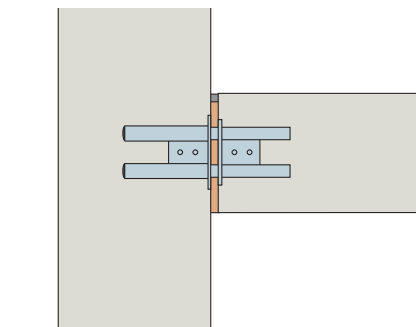

Ancon DSD

**ANCON SOLUTIONS TO JOINTS**

In most cases dowelled or keyed joints can be replaced by joints incorporating Ancon shear load connectors. These connectors are more effective at transferring load and allowing movement to take place, easier to fix on site and can prove a more cost-effective solution.

Ancon connectors can be used for movement joints in floor slabs, suspended slabs, and for replacing double columns and beams at structural movement joints. Applications in civil engineering include joints in bridge parapets, bridge abutments and diaphragm wall construction.

**Comparison of Performance with Plain Dowels**

400mm Thick Slab with Joint Width of 20mm	One Ancon DSD130	Six 32mm Dia Dowel Bars
Dowel Diameters mm	2 x 35	6 x 32
Area of Dowels mm <sup>2</sup>	1924	4825
Design Capacity kN	202.5	197.5

**1 Ancon DSD 130  
Design Capacity 202.5kN**

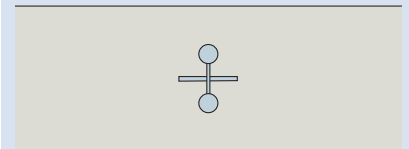

**6 Dowel Bars 32mm Diameter  
Design Capacity 197.5kN**

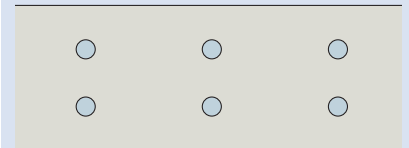

# Shear Load Connectors

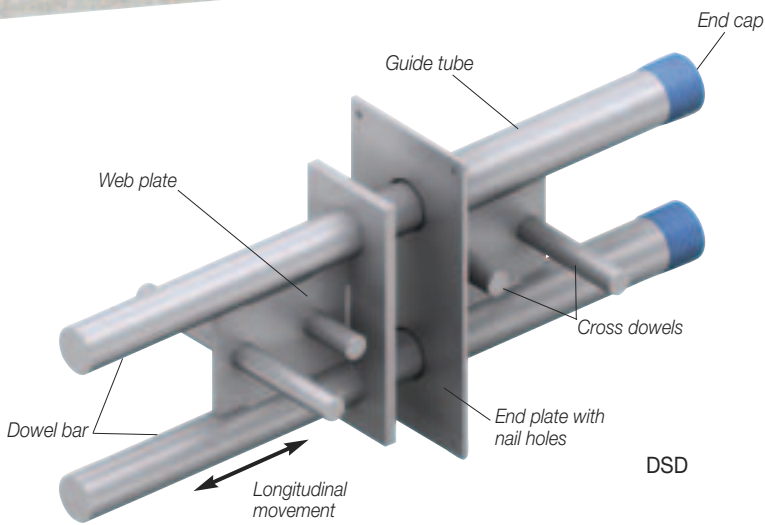

## ANCON SHEAR LOAD CONNECTORS

The DSD range of connectors offers significant advantages over plain dowels. Each connector is a two-part assembly comprising a sleeve and a dowel component. Installation is a fast and accurate process, drilling of either formwork or concrete is not required. The sleeve is simply nailed to the formwork ensuring subsequent alignment with the dowel, essential for effective movement.

They are manufactured from stainless steel to ensure a high degree of corrosion resistance with no requirement for additional protection.

Free software is available from Ancon that simplifies the design of movement joints in reinforced concrete. For a given application, Ancon's design program will calculate the size and quantity of shear load connectors required, the edge distance and spacings at which they should be installed, and details of the local reinforcement.

### Ancon DSD

The Ancon DSD is the original two-part, double dowel, shear load connector. The two dowels are Duplex stainless steel bar. The dowel component can move longitudinally within the sleeve to accommodate movement. The connector is available in ten standard sizes and has design capacities from around 20kN to over 950kN. The larger connectors can be used in joints up to 60mm wide. Larger joints can be accommodated using special dowels. Please contact Ancon's Technical Department for further information.

### Ancon DSDQ

The Ancon DSDQ shear load connector uses the same dowel component as the Ancon DSD, but the cylindrical sleeve is contained within a rectangular box section to allow lateral movement in addition to the longitudinal movement. There are nine standard sizes which have design capacities from around 30kN to over 950kN.

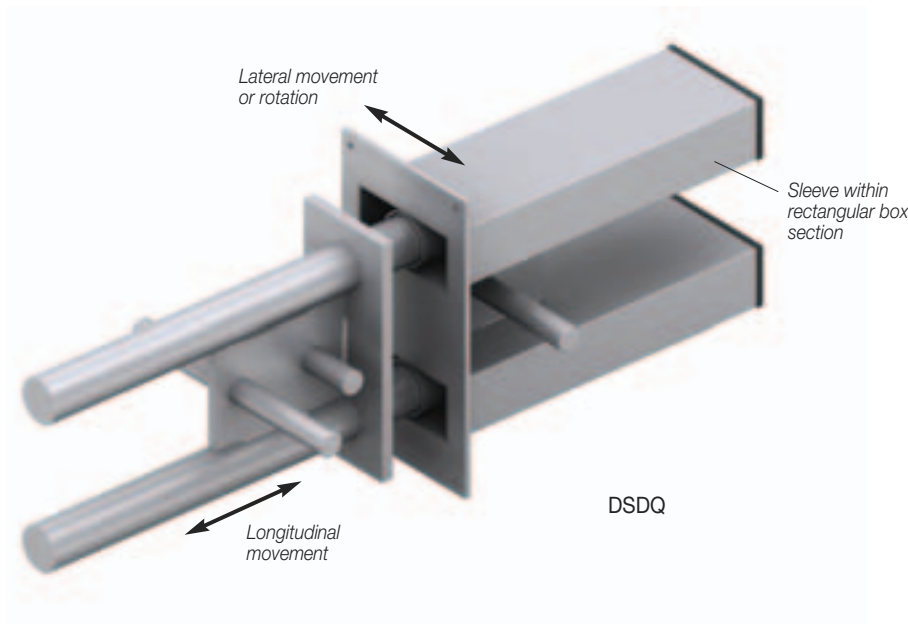

Ancon DSDQ Shear Connectors allowing rotation

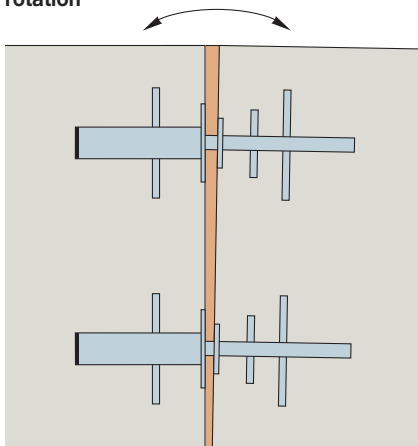

Ancon DSDQ Shear Connectors allowing movement in two directions

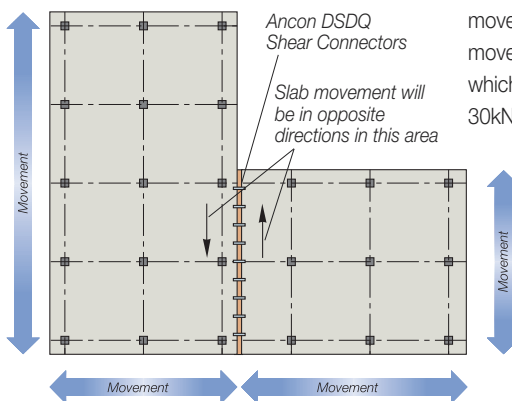

A range of stainless steel single dowel shear connectors is also available.

**Ancon ESD**

The Ancon ESD shear load connector is used where loads are small, but where alignment is critical. It is available in four sizes with each size available in two lengths. The dowel component is Duplex stainless steel bar.

**Ancon ESDQ**

The Ancon ESDQ shear load connector uses the same dowel as the ESD, but the cylindrical sleeve is contained within a rectangular box section to allow lateral movement or rotation in addition to longitudinal movement.

**Ancon ED**

The Ancon ED is a low cost dowel connector for use in floor slabs where alignment is important but loads are small. The single dowel shear connector is available in four sizes with each size available in two lengths. The sleeve component is made from a durable plastic and features an integral nail plate. The dowel component is Duplex stainless steel.

**Ancon Staisil**

The Ancon Staisil acoustic connector is designed to transfer shear loads and limit sound transmission across joints in concrete. The sleeve has Elastomer sound absorbing material between two stainless steel tubes and a nail plate for fixing to formwork. The sound transmission properties are generally unaffected by either joint width or service load. Tests in the frequency range of 100 - 3150 Hz have shown a reduction in sound transmission of 20dB. When the standard solid dowel was replaced by an antivibration dowel a reduction of 25dB was recorded.

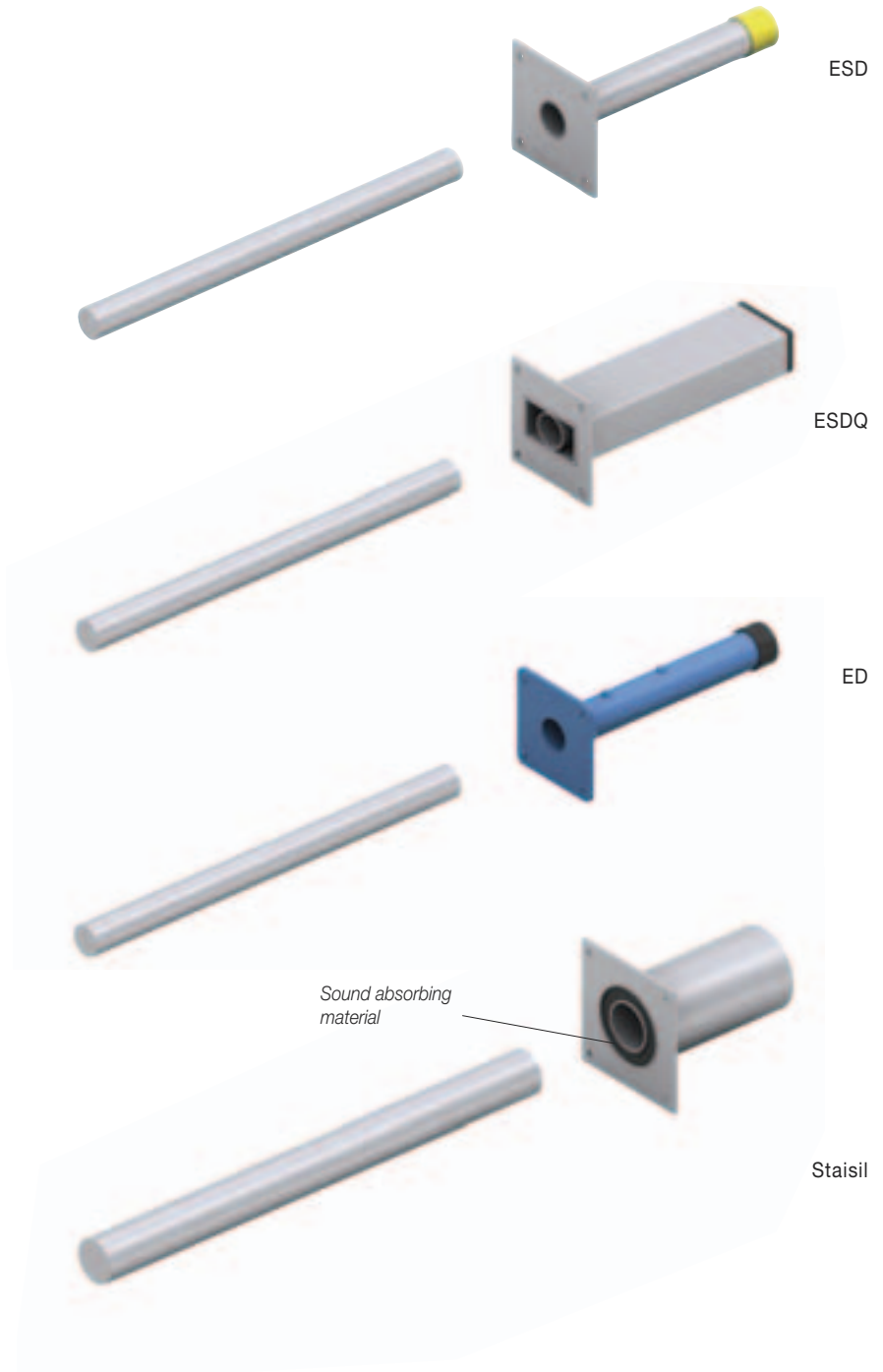



# Shear Load Connectors

## INSTALLATION PROCEDURE

The two-part assembly of all Ancon shear connectors removes the need for drilling formwork on site, supporting dowel bars and fitting debonding sleeves and end caps. The installation is a fast and accurate process.

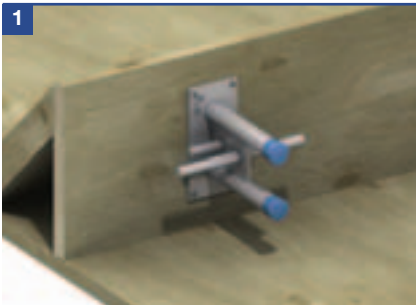
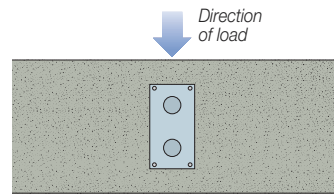

Nail the sleeve component to the shuttering ensuring that the sleeve is correctly orientated for the direction of the load. Check that the minimum spacing and edge distances are not exceeded. The label prevents debris from entering into the sleeve aperture and should not be removed at this stage.

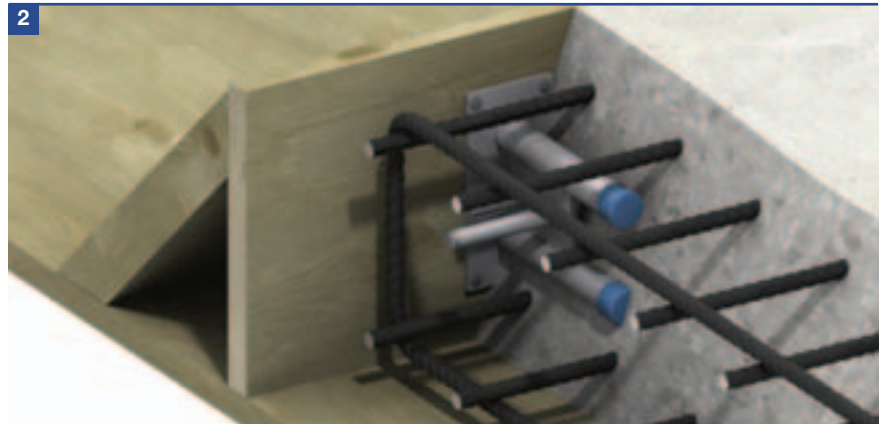

Fix the local reinforcement in position around the sleeve component together with any other reinforcement that is required, ensuring that the correct cover to the reinforcement is maintained. Pour the concrete to complete the installation of the sleeve component.



When the concrete has achieved sufficient strength, strike the shuttering. Peel off or puncture the label to reveal the holes for the dowels. Where 'Q' versions are being used, the label should only be punctured enough to allow the dowel into the cylindrical sleeve to prevent debris entering the box section.



Position compressible joint filler of the appropriate width, for applications where movement is expected between the two sections of concrete.



Push the dowel component through the joint filler (if applicable) until it is fully located in the sleeve component. It may be necessary to tap the dowel component to overcome the dimple which pinch holds the dowel in the sleeve and prevents dislocation when the concrete is vibrated.



Fix the local reinforcement in position around the dowel component together with any other reinforcement that is required, ensuring that the correct cover to the reinforcement is maintained. Pour the concrete to complete the installation of the shear connector.



### Notes:

- (i) Although installation is shown for Ancon DSD, the procedure is the same for all Ancon shear connectors.
- (ii) Where deep concrete pours are proposed, the installation will require further consideration. More robust fixing of the sleeve and dowel components will be necessary to avoid displacement during placing of the concrete.



## DESIGN CAPACITIES

Ancon DSD  $F_{Rd}$  Design Capacities (kN) for Various Joint Widths (mm) at the Maximum Slab Thickness (mm) in C30/37 Concrete

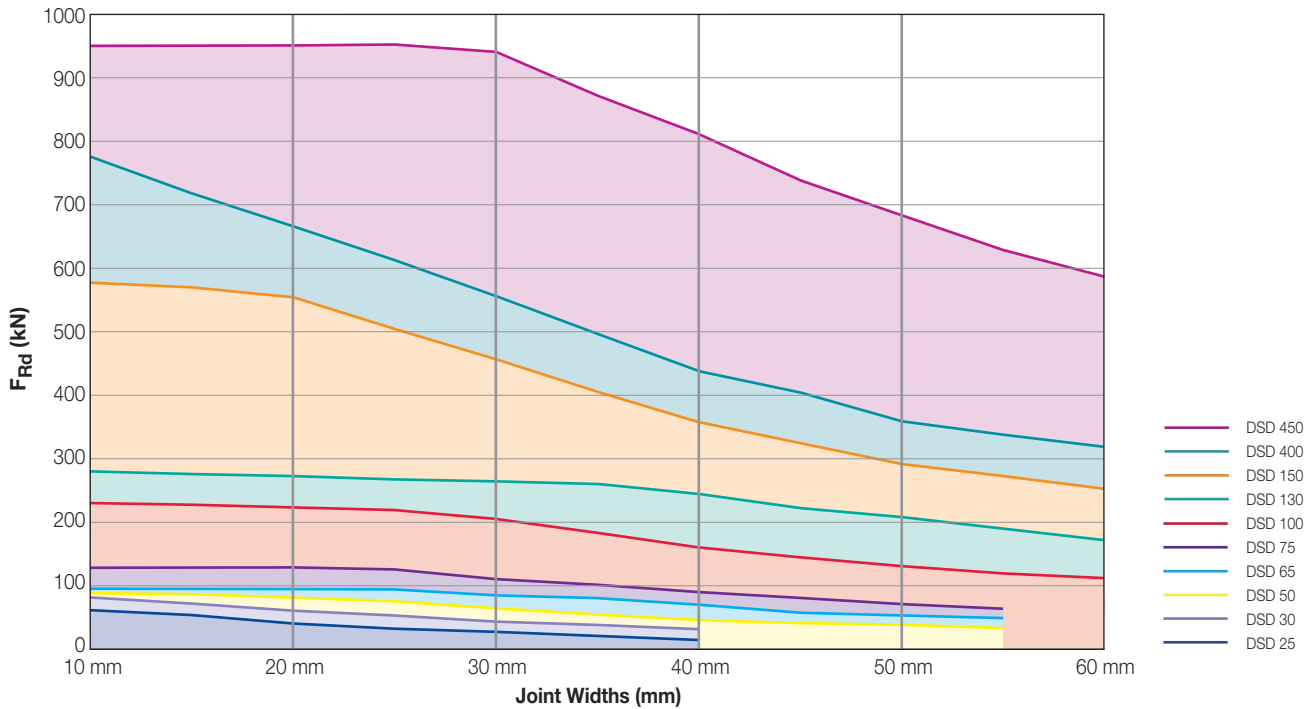

Note: For more detailed information please see page 11.

Ancon ESD  $F_{Rd}$  Design Capacities (kN) for Various Joint Widths (mm) at the Maximum Slab Thickness (mm) in C30/37 Concrete

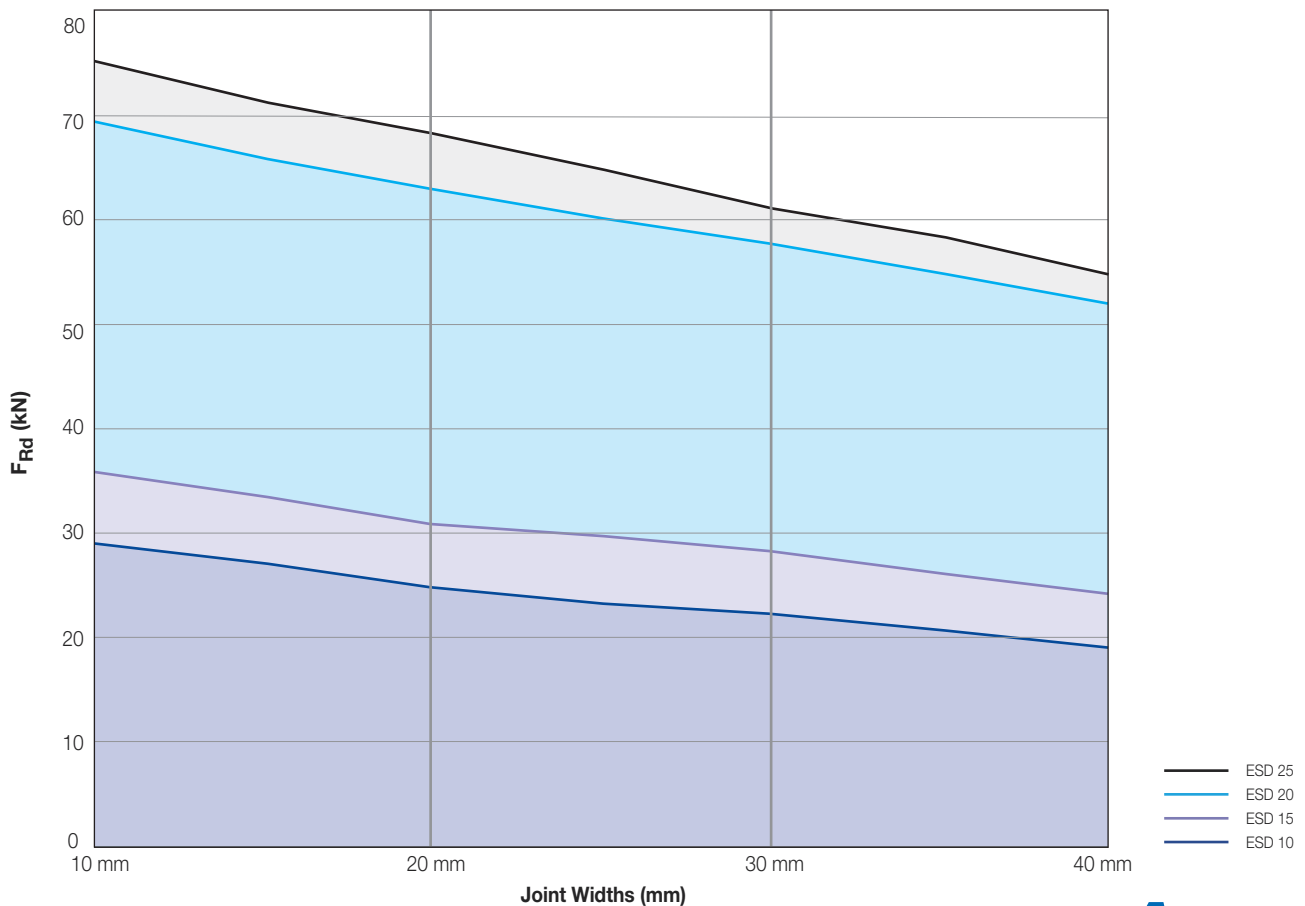

Note: For more detailed information please see page 17.

# Shear Load Connectors

## DSD AND DSDQ SHEAR CONNECTORS

$F_{Rd}$  Design Capacities (kN) for Various Joint Widths (mm) and Slab Thickness (mm) using C25/30 Concrete

Slab Thickness (mm)	Product Reference	Joint Widths (mm)					
		10	20	30	40	50	60
180	DSD 25	39.5	39.5	29.9	23.2	-	-
200		45.7	41.8	29.9	23.2	-	-
220		52.3	41.8	29.9	23.2	-	-
240		59.3	41.8	29.9	23.2	-	-
260		66.7	41.8	29.9	23.2	-	-
280		69.6	41.8	29.9	23.2	-	-
180	DSD/DSDQ 30	42.7	42.7	42.7	34.7	-	-
200		49.2	49.2	44.6	34.7	-	-
220		56.1	56.1	44.6	34.7	-	-
240		63.4	62.4	44.6	34.7	-	-
260		71.1	62.4	44.6	34.7	-	-
280		79.1	62.4	44.6	34.7	-	-
180	DSD/DSDQ 50	43.8	43.8	43.8	43.8	40.4	-
200		50.3	50.3	50.3	49.4	40.4	-
220		57.3	57.3	57.3	49.4	40.4	-
240		64.6	64.6	63.5	49.4	40.4	-
260		72.3	72.3	63.5	49.4	40.4	-
280		80.4	80.4	63.5	49.4	40.4	-
180	DSD/DSDQ 65	54.6	54.6	54.6	54.6	54.6	-
200		62.2	62.2	62.2	62.2	55.4	-
220		64.3	64.3	64.3	64.3	55.4	-
240		68.6	68.6	68.6	67.7	55.4	-
260		76.4	76.4	76.4	67.7	55.4	-
280		84.6	84.6	84.6	67.7	55.4	-
240	DSD/DSDQ 75	86.1	86.1	86.1	86.1	73.8	-
260		89.1	89.1	89.1	89.1	73.8	-
280		94.8	94.8	94.8	90.1	73.8	-
300		104.0	104.0	104.0	90.1	73.8	-
320		113.6	113.6	113.6	90.1	73.8	-
340		123.4	123.4	115.9	90.1	73.8	-
320	DSD/DSDQ 100	161.5	157.6	154.0	150.5	133.6	114.0
340		166.5	162.6	158.8	155.2	133.6	114.0
360		170.8	166.7	162.8	159.1	133.6	114.0
380		183.2	178.9	174.7	161.4	133.6	114.0
400		196.0	191.4	186.9	161.4	133.6	114.0
420		209.1	204.2	199.4	161.4	133.6	114.0
360	DSD/DSDQ 130	185.0	181.3	177.7	174.3	171.0	167.9
380		193.4	189.5	185.8	182.2	178.8	175.5
400		206.6	202.5	198.5	194.7	191.0	176.1
420		220.2	215.8	211.5	207.5	203.6	176.1
440		234.0	229.3	224.8	220.5	206.5	176.1
460		248.2	243.2	238.4	233.8	206.5	176.1
450	DSD/DSDQ 150	280.8	276.0	271.3	266.8	262.4	253.6
500		308.2	302.8	297.7	292.8	288.0	253.6
550		339.7	333.8	328.2	322.7	297.4	253.6
600		380.5	373.9	367.6	359.3	297.4	253.6
700		465.4	457.3	449.6	359.3	297.4	253.6
800		485.6	477.2	451.2	359.3	297.4	253.6
600	DSD/DSDQ 400	441.1	434.6	428.3	422.2	369.3	315.0
650		485.1	478.0	471.0	441.8	369.3	315.0
700		529.9	522.1	514.5	441.8	369.3	315.0
800		620.9	611.8	554.1	441.8	369.3	315.0
900		712.7	666.4	554.1	441.8	369.3	315.0
1000		745.3	666.4	554.1	441.8	369.3	315.0
600	DSD/DSDQ 450	485.1	485.1	485.1	485.1	485.1	485.1
650		515.5	515.5	515.5	515.5	515.5	515.5
700		561.4	561.4	561.4	561.4	561.4	561.4
800		654.4	654.4	654.4	654.4	654.4	586.9
900		747.9	747.9	747.9	747.9	684.7	586.9
1000		840.1	840.1	840.1	811.4	684.7	586.9

**F<sub>Rd</sub> Design Capacities (kN) for Various Joint Widths (mm) and Slab Thickness (mm) using C30/37 Concrete**

Slab Thickness (mm)	Product Reference	Joint Widths (mm)						
		10	20	30	40	50	60	
180	DSD 25	44.7	41.8	29.9	23.2	-	-	
200		51.8	41.8	29.9	23.2	-	-	
220		59.3	41.8	29.9	23.2	-	-	
240		67.3	41.8	29.9	23.2	-	-	
260		69.6	41.8	29.9	23.2	-	-	
280		69.6	41.8	29.9	23.2	-	-	
180	DSD/DSDQ 30	48.3	48.3	44.6	34.7	-	-	
200		55.7	55.7	44.6	34.7	-	-	
220		63.6	62.4	44.6	34.7	-	-	
240		71.8	62.4	44.6	34.7	-	-	
260		80.5	62.4	44.6	34.7	-	-	
280		89.7	62.4	44.6	34.7	-	-	
180	DSD/DSDQ 50	49.6	49.6	49.6	49.4	40.4	-	
200		57.0	57.0	57.0	49.4	40.4	-	
220		64.9	64.9	63.5	49.4	40.4	-	
240		73.2	73.2	63.5	49.4	40.4	-	
260		82.0	82.0	63.5	49.4	40.4	-	
280		91.1	88.9	63.5	49.4	40.4	-	
180	DSD/DSDQ 65	61.8	61.8	61.8	61.8	55.4	-	
200		70.5	70.5	70.5	67.7	55.4	-	
220		72.8	72.8	72.8	67.7	55.4	-	
240		77.8	77.8	77.8	67.7	55.4	-	
260		86.6	86.6	86.6	67.7	55.4	-	
280		95.8	95.8	87.1	67.7	55.4	-	
240	DSD/DSDQ 75	97.6	97.6	97.6	90.1	73.8	-	
260		101.0	101.0	101.0	90.1	73.8	-	
280		107.4	107.4	107.4	90.1	73.8	-	
300		117.9	117.9	115.9	90.1	73.8	-	
320		128.7	128.7	115.9	90.1	73.8	-	
340		139.9	139.9	115.9	90.1	73.8	-	
320		DSD/DSDQ 100	183.0	178.7	174.5	161.4	133.6	114.0
340			188.7	184.3	180.0	161.4	133.6	114.0
360	193.5		188.9	184.5	161.4	133.6	114.0	
380	207.7		202.7	198.0	161.4	133.6	114.0	
400	222.2		216.9	203.9	161.4	133.6	114.0	
420	237.0		231.4	203.9	161.4	133.6	114.0	
360	DSD/DSDQ 130	209.7	205.5	201.4	197.6	193.8	176.1	
380		219.2	214.8	210.6	206.5	202.7	176.1	
400		234.2	229.5	225.0	220.7	206.5	176.1	
420		249.5	244.5	239.8	235.1	206.5	176.1	
440		265.2	259.9	254.8	249.5	206.5	176.1	
460		281.2	275.6	270.2	249.5	206.5	176.1	
450		DSD/DSDQ 150	318.2	312.8	307.5	302.3	297.4	253.6
500			349.2	343.2	337.4	331.8	297.4	253.6
550	385.0		378.3	371.9	359.3	297.4	253.6	
600	431.2		423.8	416.6	359.3	297.4	253.6	
700	527.4		518.3	451.2	359.3	297.4	253.6	
800	582.7		553.0	451.2	359.3	297.4	253.6	
600	DSD/DSDQ 400	499.9	492.5	485.4	441.8	369.3	315.0	
650		549.8	541.7	533.8	441.8	369.3	315.0	
700		600.5	591.7	554.1	441.8	369.3	315.0	
800		703.7	666.4	554.1	441.8	369.3	315.0	
900		778.7	666.4	554.1	441.8	369.3	315.0	
1000		778.7	666.4	554.1	441.8	369.3	315.0	
600		DSD/DSDQ 450	549.8	549.8	549.8	549.8	549.8	549.8
650			584.2	584.2	584.2	584.2	584.2	584.2
700	636.2		636.2	636.2	636.2	636.2	586.9	
800	741.7		741.7	741.7	741.7	684.7	586.9	
900	847.6		847.6	847.6	811.4	684.7	586.9	
1000	952.1	952.1	941.1	811.4	684.7	586.9		

**DSD Design Example**

Slab thickness	= 400mm	
Joint width	= 30mm	
Concrete strength	= C30/37	
Characteristic dead load	= 100kN/m	$\gamma_G = 1.35^*$
Characteristic imposed load	= 120kN/m	$\gamma_Q = 1.5^*$
Design load	= $(100 \times 1.35) + (120 \times 1.5) = 315\text{kN/m}$	

F <sub>Rd</sub> (Design capacity)	Maximum centres	Either connector would be acceptable, although
DSD100 = 203.9kN	= 203.9 / 315 = 0.647m use 600mm	using DSD130s at 700mm centres would minimise
DSD130 = 225.0kN	= 225.0 / 315 = 0.714m use 700mm	the number of connectors to be installed.

\*The partial safety factors of 1.35 ( $\gamma_G$ ) and 1.5 ( $\gamma_Q$ ) are those recommended in EN 1990 Eurocode: Basis for structural design. For designs to Eurocode 2, please refer to the national annex for the factors to be used in the country concerned. For designers to BS8110,  $\gamma_G = 1.4$  and  $\gamma_Q = 1.6$ . Other national standards may require different safety factors.



# Shear Load Connectors

## Reinforcement Details

Local reinforcement is required around each connector to guarantee that the forces are transferred between the connectors and the concrete. Correct detailing in accordance with appropriate design codes and the recommendations provided here will ensure Ancon DSD and DSDQ connectors attain their full capacity.

The tables show proposals for the type and spacing of the main reinforcement, together with details of reinforcement above and below the connectors.

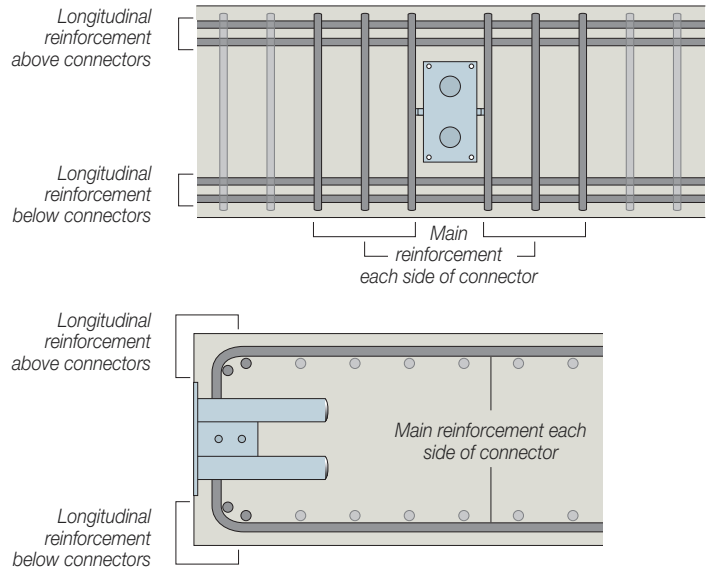

Based on C25/30 concrete, maximum slab depth (see table on page 10) and 20mm joint

DSD/DSDQ Reference	H8	Options for Main Reinforcement (No. of U-bars each side)				
		H10	H12	H14	H16	H20
25*	3	2	-	-	-	-
30	-	3	2	-	-	-
50	-	3	3	-	-	-
65	-	4	3	-	-	-
75	-	5	4	3	-	-
100	-	-	5	4	3	-
130	-	-	-	5	4	3
150	-	-	-	-	6	4
400	-	-	-	-	7	5
450	-	-	-	-	9	7

DSD/DSDQ Reference	H8	Options for Longitudinal Reinforcement (No. of bars top and bottom)				
		H10	H12	H14	H16	H20
25*	2	2	-	-	-	-
30	2	2	-	-	-	-
50	-	2	2	-	-	-
65	-	2	2	-	-	-
75	-	3	2	-	-	-
100	-	-	3	2	2	-
130	-	-	3	3	2	-
150	-	-	-	-	4	3
400	-	-	-	-	5	3
450	-	-	-	-	6	4

Based on C30/37 concrete, maximum slab depth (see table on page 11) and 20mm joint

DSD/DSDQ Reference	H8	Options for Main Reinforcement (No. of U-bars each side)				
		H10	H12	H14	H16	H20
25*	3	2	-	-	-	-
30	-	3	2	-	-	-
50	-	4	3	-	-	-
65	-	4	3	-	-	-
75	-	5	4	3	-	-
100	-	-	6	5	4	-
130	-	-	-	5	4	3
150	-	-	-	-	6	5
400	-	-	-	-	6	5
450	-	-	-	-	9	7

DSD/DSDQ Reference	H8	Options for Longitudinal Reinforcement (No. of bars top and bottom)				
		H10	H12	H14	H16	H20
25*	2	2	-	-	-	-
30	2	2	-	-	-	-
50	-	2	2	-	-	-
65	-	2	2	-	-	-
75	-	3	2	-	-	-
100	-	-	3	3	2	-
130	-	-	4	3	2	-
150	-	-	-	-	4	3
400	-	-	-	-	5	3
450	-	-	-	-	7	5

\* DSD only

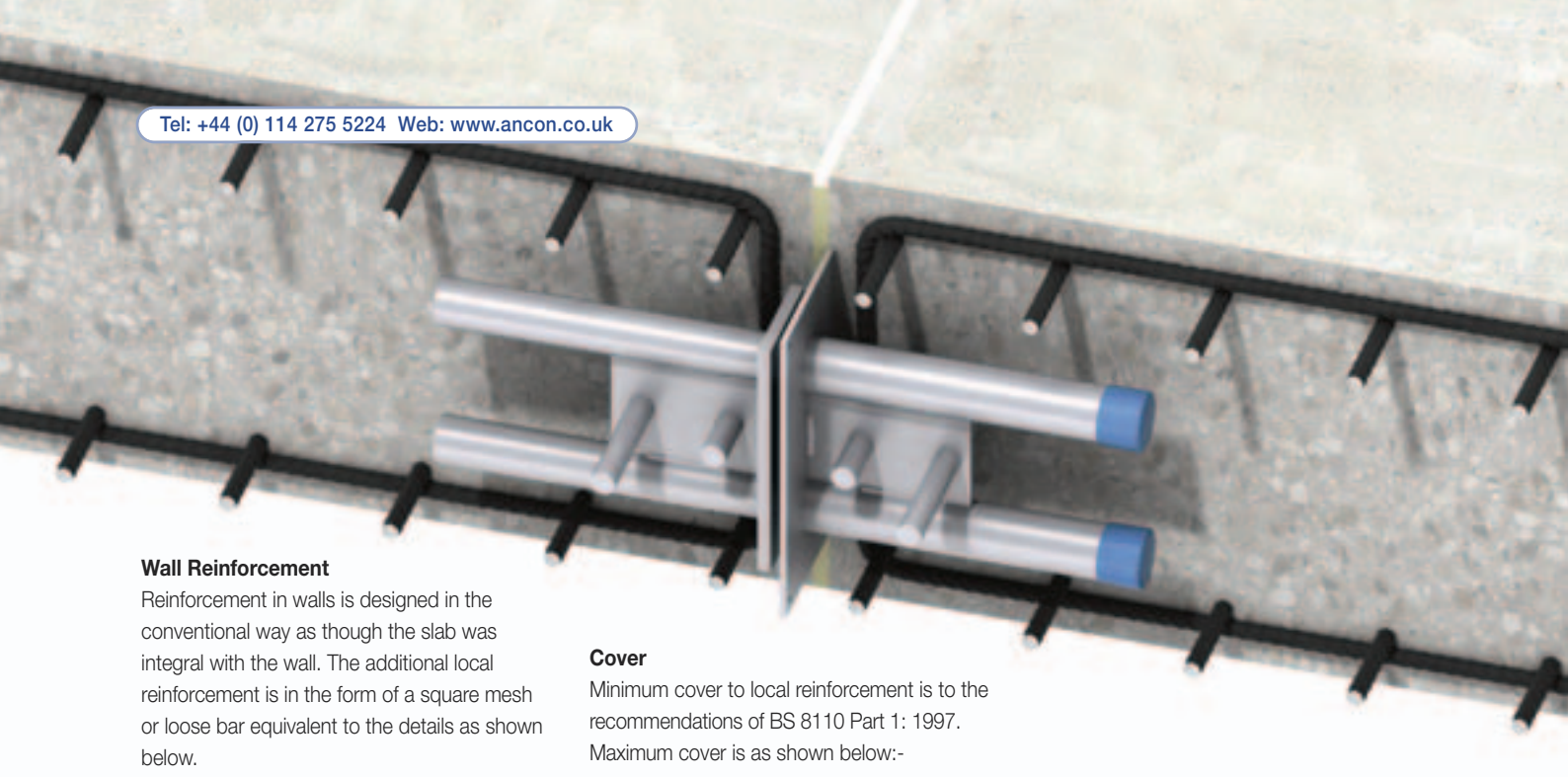

### Wall Reinforcement

Reinforcement in walls is designed in the conventional way as though the slab was integral with the wall. The additional local reinforcement is in the form of a square mesh or loose bar equivalent to the details as shown below.

### Cover

Minimum cover to local reinforcement is to the recommendations of BS 8110 Part 1: 1997. Maximum cover is as shown below:-

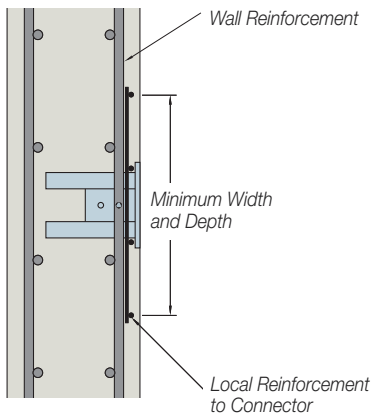

Ref DSD DSDQ	Max Cover to Face (mm)
25*	30
30	30
50	30
65	40
75	50
100	50
130	50
150	50
400	60
450	60

\* DSD only

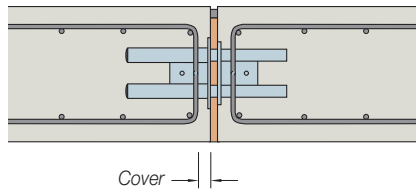

Ref DSD DSDQ	Bar Diameter (mm)	Maximum Centres (mm)	Minimum Width/Depth (mm)
25*	8	100	300
30	8	100	300
50	8	100	300
65	10	100	400
75	12	150	450
100	12	150	450
130	12	150	600
150	12	175	700

\* DSD only

### Reinforcement for DSD 75s in a Wall

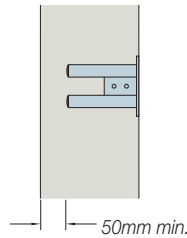
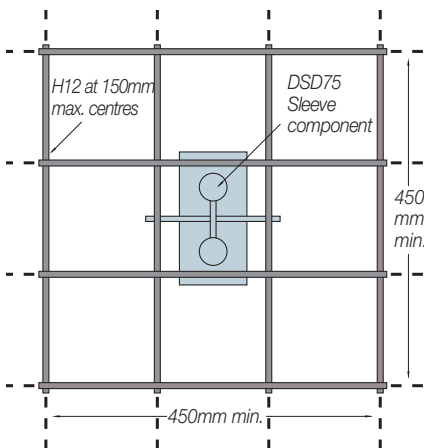

Where a sleeve component is cast into a wall the thickness of the wall should be at least 50mm more than the length of the sleeve.

# Shear Load Connectors



## Dowel Component

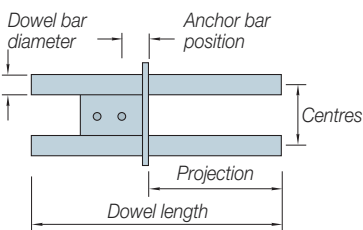

## DSD Sleeve

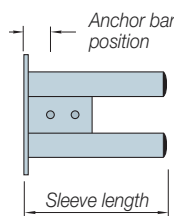

## DSDQ Sleeve

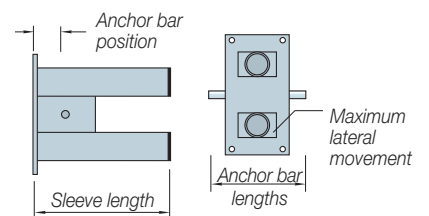

## Dimensions

Ref DSD DSDQ	Dowel Component						DSD Sleeve			DSDQ Sleeve			
	Overall Length	Dowel Dia	Dowel Centres	Dowel Projection	Anchor Bar Position	Anchor Bar Lengths	Overall Length	Anchor Bar Position	Anchor Bar Lengths	Overall Length	Anchor Bar Position	Anchor Bar Length	Lateral Mov't
25*	250	14	40	120	31	50/110	120	28	50/110	-	-	-	-
30	260	16	48	120	31	50/110	120	28	50/110	140	33	70	26
50	280	18	50	130	31	50/130	135	28	50/130	160	33	70	25
65	300	20	65	150	31	50/130	155	29	50/130	175	33	70	21
75	340	22	75	150	33	50/150	155	31	50/150	175	33	120	20
100	400	30	100	210	34	80/170	210	36	80/170	235	54	170	41
130	470	35	105	260	34	80/170	265	36	80/170	275	59	170	36
150	550	42	120	270	54	80/210	275	41	80/210	305	54	170	21
400	660	52	160	330	70	130/300	335	70	130/300	350	64	300	27
450	690	65	180	360	80	130/300	370	80	130/300	400	89	300	54

Notes: \*DSD only. All dimensions are in millimetres (mm).

## Edge Distance and Spacing

The minimum edge distance and spacing of all Ancon shear load connectors is determined by the depth of slab and is illustrated in the adjacent drawing.

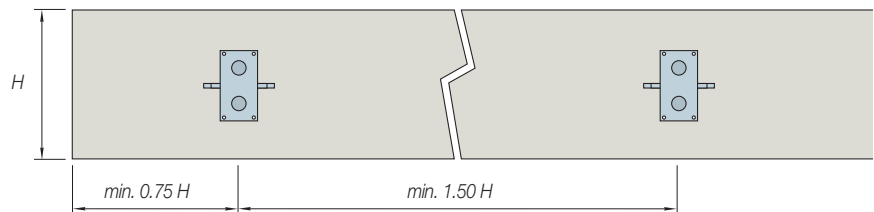



## ANCON ESD AND ESDQ SHEAR CONNECTORS

### Dowel Component

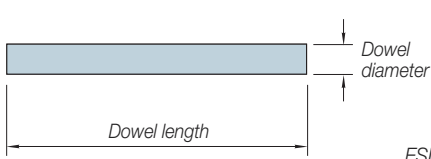

### ESD Sleeve

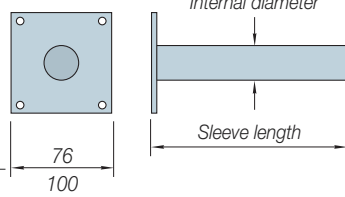

### ESDQ Sleeve

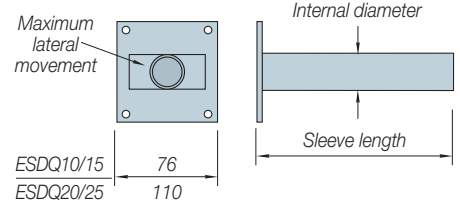

### Dimensions

Ref ESD ESDQ	Dowel Component		ESD Sleeve		ESDQ Sleeve		
	Dowel Diameter	Dowel Length	Internal Diameter	Sleeve Length	Internal Diameter	Sleeve Length	Max. Lateral Movement
10 300	20	300	21	175	21	175	20
10 400	20	400	21	225	21	225	20
15 300	22	300	23	175	23	175	20
15 400	22	400	23	225	23	225	20
20 300	30	300	31	175	31	175	41
20 400	30	400	31	225	31	225	41
25 350	35	350	36	200	36	200	36
25 470	35	470	36	260	36	260	36

Note: Example Ref ESD10 300

## ANCON ED SHEAR CONNECTORS

### Dowel Component

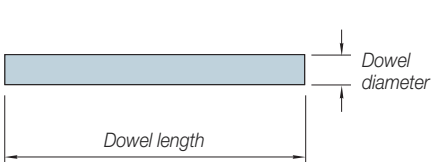

### ED Sleeve

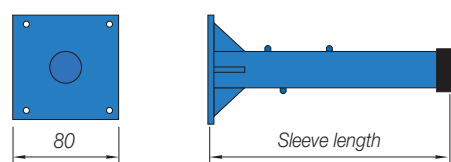

### Dimensions

Ref ED	Dowel Length	Dowel Diameter	Sleeve Length
10 300	300	20	170
10 400	400	20	220
15 300	300	22	170
15 400	400	22	220
20 300	300	30	170
20 400	400	30	220
25 350	350	35	195
25 470	470	35	260

## ANCON STAISIL ACOUSTIC CONNECTORS

### Dowel Component

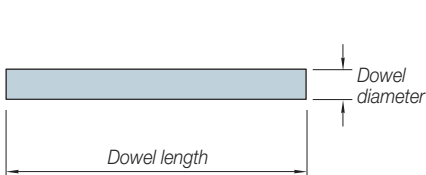

### Staisil Sleeve

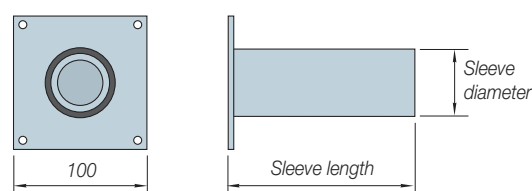

### Dimensions

Ref	Dowel Length	Dowel Diameter	Sleeve Length	Sleeve Diameter
Staisil	400	35	127	64

### Edge Distance and Spacing

The minimum edge distance and spacing of all Ancon shear load connectors is determined by the depth of slab and is illustrated in the adjacent drawing.

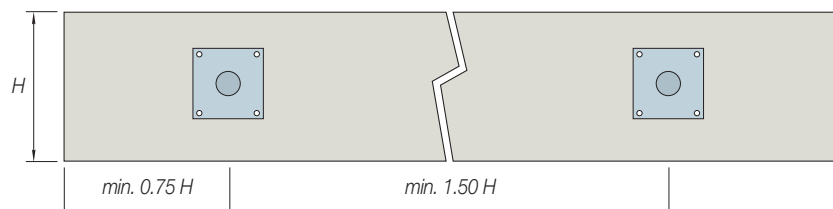

# Shear Load Connectors

**F<sub>Rd</sub> Design Capacities (kN) for Various Joint Widths (mm) and Slab Thickness (mm) using C25/30 Concrete**

Slab Thickness (mm)	Product Reference	Joint Widths (mm)			
		10	20	30	40
180	ESD/ESDQ 10	25.6	25.6	22.4	19.7
200		26.7	25.7	22.4	19.7
220		26.7	25.7	22.4	19.7
240		26.7	25.7	22.4	19.7
260		26.7	25.7	22.4	19.7
280		26.7	25.7	22.4	19.7
180	ESD/ESDQ 15	28.7	28.7	28.1	24.9
200		32.3	31.9	28.1	24.9
220		32.3	31.9	28.1	24.9
240		32.3	31.9	28.1	24.9
260		32.3	31.9	28.1	24.9
280		32.3	31.9	28.1	24.9
220	ESD/ESDQ 20	47.3	47.3	47.3	47.3
240		54.9	54.9	54.9	52.7
260		60.0	60.0	57.8	52.7
280		60.0	60.0	57.8	52.7
300		60.0	60.0	57.8	52.7
350		60.0	60.0	57.8	52.7
240	ESD/ESDQ 25	56.8	56.8	56.8	55.7
260		65.0	65.0	61.5	55.7
280		73.7	68.0	61.5	55.7
300		75.4	68.0	61.5	55.7
350		75.4	68.0	61.5	55.7
400		75.4	68.0	61.5	55.7

Slab Thickness (mm)	Product Reference	Joint Widths (mm)			
		10	20	30	40
180	ED 10	25.6	25.6	22.4	19.7
200		26.7	25.7	22.4	19.7
220		26.7	25.7	22.4	19.7
240		26.7	25.7	22.4	19.7
260		26.7	25.7	22.4	19.7
280		26.7	25.7	22.4	19.7
180	ED 15	28.7	28.7	28.1	24.9
200		32.3	31.9	28.1	24.9
220		32.3	31.9	28.1	24.9
240		32.3	31.9	28.1	24.9
260		32.3	31.9	28.1	24.9
280		32.3	31.9	28.1	24.9
220	ED 20	47.3	47.3	47.3	47.3
240		54.9	54.9	54.9	52.7
260		60.0	60.0	57.8	52.7
280		60.0	60.0	57.8	52.7
300		60.0	60.0	57.8	52.7
350		60.0	60.0	57.8	52.7
240	ED 25	56.8	56.8	56.8	55.7
260		65.0	65.0	61.5	55.7
280		73.7	68.0	61.5	55.7
300		75.4	68.0	61.5	55.7
350		75.4	68.0	61.5	55.7
400		75.4	68.0	61.5	55.7

Slab Thickness (mm)	Product Reference	Joint Widths (mm)			
		10	20	30	40
160	Staisil	22.3	22.3	22.3	22.3
180		27.8	27.4	24.9	22.7
200		30.3	27.4	24.9	22.7
220		30.3	27.4	24.9	22.7
240		30.3	27.4	24.9	22.7
260		30.3	27.4	24.9	22.7

**F<sub>Rd</sub> Design Capacities (kN) for Various Joint Widths (mm) and Slab Thickness (mm) using C30/37 Concrete**

Slab Thickness (mm)	Product Reference	Joint Widths (mm)			
		10	20	30	40
180	ESD/ESDQ 10	29.1	25.7	22.4	19.7
200		29.6	25.7	22.4	19.7
220		29.6	25.7	22.4	19.7
240		29.6	25.7	22.4	19.7
260		29.6	25.7	22.4	19.7
280		29.6	25.7	22.4	19.7
180	ESD/ESDQ 15	32.6	31.9	28.1	24.9
200		36.3	31.9	28.1	24.9
220		36.3	31.9	28.1	24.9
240		36.3	31.9	28.1	24.9
260		36.3	31.9	28.1	24.9
280		36.3	31.9	28.1	24.9
220	ESD/ESDQ 20	53.6	53.6	53.6	52.7
240		62.2	62.2	57.8	52.7
260		69.9	63.5	57.8	52.7
280		69.9	63.5	57.8	52.7
300		69.9	63.5	57.8	52.7
350		69.9	63.5	57.8	52.7
240	ESD/ESDQ 25	64.4	64.4	61.5	55.7
260		73.7	68.0	61.5	55.7
280		75.4	68.0	61.5	55.7
300		75.4	68.0	61.5	55.7
350		75.4	68.0	61.5	55.7
400		75.4	68.0	61.5	55.7

Slab Thickness (mm)	Product Reference	Joint Widths (mm)			
		10	20	30	40
180	ED 10	29.1	25.7	22.4	19.7
200		29.6	25.7	22.4	19.7
220		29.6	25.7	22.4	19.7
240		29.6	25.7	22.4	19.7
260		29.6	25.7	22.4	19.7
280		29.6	25.7	22.4	19.7
180	ED 15	32.6	31.9	28.1	24.9
200		36.3	31.9	28.1	24.9
220		36.3	31.9	28.1	24.9
240		36.3	31.9	28.1	24.9
260		36.3	31.9	28.1	24.9
280		36.3	31.9	28.1	24.9
220	ED 20	53.6	53.6	53.6	52.7
240		62.2	62.2	57.8	52.7
260		69.9	63.5	57.8	52.7
280		69.9	63.5	57.8	52.7
300		69.9	63.5	57.8	52.7
350		69.9	63.5	57.8	52.7
240	ED 25	64.4	64.4	61.5	55.7
260		73.7	68.0	61.5	55.7
280		75.4	68.0	61.5	55.7
300		75.4	68.0	61.5	55.7
350		75.4	68.0	61.5	55.7
400		75.4	68.0	61.5	55.7

Slab Thickness (mm)	Product Reference	Joint Widths (mm)			
		10	20	30	40
160	Staisil	25.3	25.3	24.9	22.7
180		30.3	27.4	24.9	22.7
200		30.3	27.4	24.9	22.7
220		30.3	27.4	24.9	22.7
240		30.3	27.4	24.9	22.7
260		30.3	27.4	24.9	22.7

**ESD Design Example**

Slab thickness	= 220mm
Joint width	= 30mm
Concrete strength	= C30/37
Characteristic dead load	= 20kN/m
Characteristic imposed load	= 26kN/m
Design load	= (20 x 1.35) + (26 x 1.5) = 66kN/m

$$\gamma_G = 1.35^*$$

$$\gamma_Q = 1.5^*$$

F <sub>Rd</sub> (Design capacity)	Maximum centres	
ESD10 = 22.4kN	= 22.4 / 66 = 0.339m use 330mm	Any of the three connectors would be acceptable, although using ESD20s at 800mm centres would minimise the number of connectors to be installed.
ESD15 = 28.1kN	= 28.1 / 66 = 0.426m use 400mm	
ESD20 = 53.6kN	= 53.6 / 66 = 0.812m use 800mm	

\*The partial safety factors of 1.35 ( $\gamma_G$ ) and 1.5 ( $\gamma_Q$ ) are those recommended in EN 1990 Eurocode: Basis for structural design. For designs to Eurocode 2, please refer to the national annex for the factors to be used in the country concerned. For designers to BS8110,  $\gamma_G = 1.4$  and  $\gamma_Q = 1.6$ . Other national standards may require different safety factors.



# Shear Load Connectors

## Reinforcement Details

Local reinforcement is required around each connector to guarantee that the forces are transferred between the connectors and the concrete. Correct detailing in accordance with appropriate design codes and the recommendations provided here will ensure Ancon ESD, ESDQ, ED and Staisil connectors attain their full capacity.

The tables show proposals for the type and spacing of the main reinforcement, together with details of reinforcement above and below the connectors.

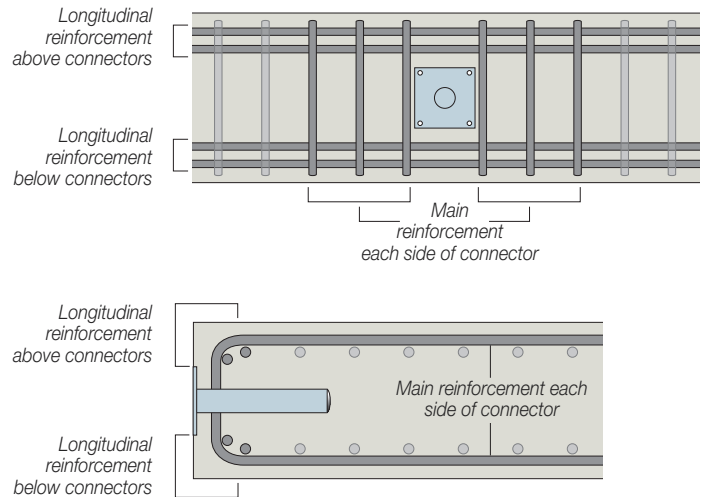
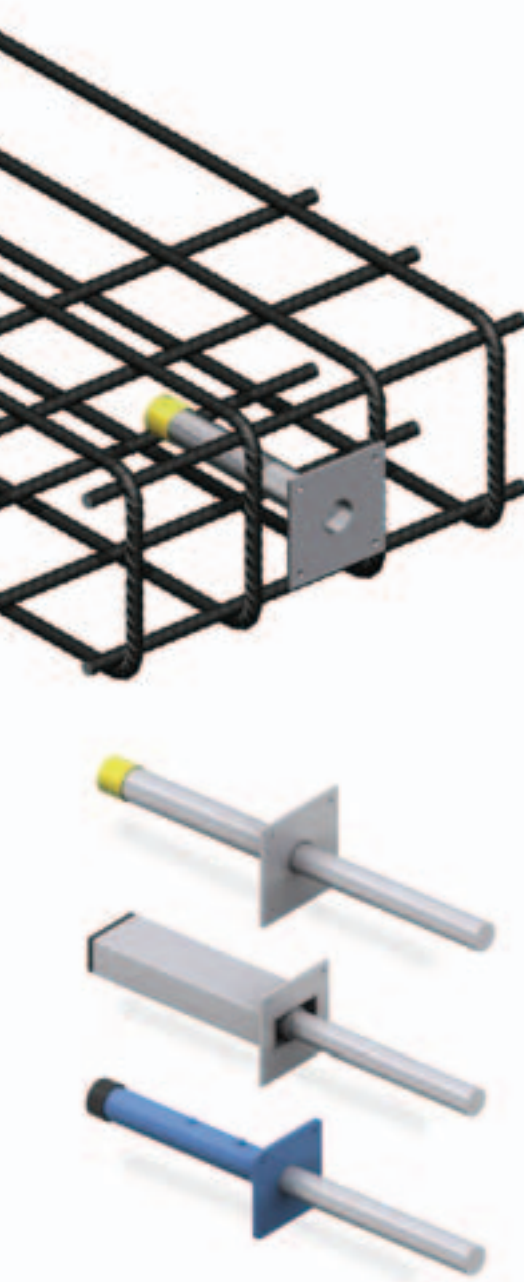

Based on C25/30 concrete, maximum slab depth (see table on page 16) and 20mm joint

ED/ESD/ESDQ/Staisil Reference	Options for Main Reinforcement (No. of U-bars each side)			
	H8	H10	H12	H14
10	2	1	-	-
15	2	2	-	-
20	3	2	2	-
25	-	3	3	2
Staisil	2	2	-	-

ED/ESD/ESDQ/Staisil Reference	Options for Longitudinal Reinforcement (No. of bars top and bottom)			
	H8	H10	H12	H14
10	2	2	-	-
15	2	2	-	-
20	2	2	2	-
25	3	2	2	-
Staisil	2	2	-	-

Based on C30/37 concrete, maximum slab depth (see table on page 17) and 20mm joint

ED/ESD/ESDQ/Staisil Reference	Options for Main Reinforcement (No. of U-bars each side)			
	H8	H10	H12	H14
10	2	2	-	-
15	2	2	-	-
20	3	3	2	-
25	-	3	3	2
Staisil	2	2	-	-

ED/ESD/ESDQ/Staisil Reference	Options for Longitudinal Reinforcement (No. of bars top and bottom)			
	H8	H10	H12	H14
10	2	2	-	-
15	2	2	-	-
20	2	2	2	-
25	3	2	2	-
Staisil	2	2	-	-

## APPLICATIONS

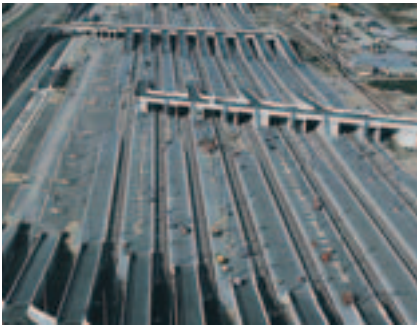

Channel Tunnel Terminal, UK



Forum Shopping Centre, Algarve



Melbourne Cricket Ground, Australia



Scottish Widows, Edinburgh, UK



Olympic Stadium, Sydney, Australia

## OTHER ANCON PRODUCTS

### Reinforcement Continuity Systems

Reinforcement Continuity Systems are an increasingly popular means of maintaining continuity of reinforcement at construction joints in concrete. Ancon Eazistrip is approved by UK CARES and consists of pre-bent bars housed within a galvanised steel casing. Once installed, the protective cover is removed and the bars are straightened. Ancon Starter Bars are supplied fixed to an Ancon coupler. Once cast in concrete, the coupler's end cap is removed and a threaded continuation bar is installed with a calibrated torque wrench to complete the connection.



### Reinforcing Bar Couplers

The use of reinforcing bar couplers can provide significant advantages over lapped joints. Design and construction of the concrete can be simplified and the amount of reinforcement required can be reduced. Because the strength of a mechanical splice is independent of the concrete in which it is located, the joint can also remain unaffected by any loss of cover. The range includes threaded and mechanically bolted couplers.



### Punching Shear Reinforcement

Used within a slab to provide additional reinforcement around columns, Ancon Shearfix is the ideal solution to the design and construction problems associated with punching shear. The system consists of double-headed studs welded to flat rails, positioned around the column. The shear load from the slab is transferred through the studs into the column.



### Insulated Balcony Connections

Ancon Isolan connectors join external concrete balconies to internal floor slabs. Used to minimise cold bridging, they provide continuity to the thermal insulation. Standard systems, comprising rigid CFC-free polystyrene insulation and duplex stainless steel shear reinforcement, suit most depths of cantilevered and simply supported balconies. Conventional reinforcing bars are used to provide the tension and compression reinforcement.



### Channels and Bolts for Fixing to Concrete

Cast-in channels are used for fixing masonry support systems to the edges of concrete floors and beams. Channels are available in different sizes ranging from simple self anchoring channels for restraints, to large capacity channels with integral anchors. A selection of channels can also be supplied plain-backed for surface fixing. Stainless steel expansion bolts and resin anchors complete the range.



## Ancon Building Products

President Way, President Park  
Sheffield S4 7UR  
United Kingdom  
Tel: +44 (0) 114 275 5224  
Fax: +44 (0) 114 276 8543  
Email: info@ancon.co.uk  
Visit: www.ancon.co.uk

## Ancon (Middle East) FZE

PO Box 17225  
Jebel Ali  
Dubai  
United Arab Emirates  
Tel: +971 (0) 4 883 4346  
Fax: +971 (0) 4 883 4347  
Email: anconcl@emirates.net.ae

## Ancon Building Products

114 Kurrajong Avenue  
Mount Druitt  
Sydney  
NSW 2770  
Australia  
Tel: +61 (0) 2 8808 1111  
Fax: +61 (0) 2 9675 3390  
Email: pac.ancon@anconbp.com.au  
Visit: www.anconbp.com.au

## Ancon (Schweiz) AG

Gewerbezone Widalmi 10  
3216 Ried bei Kerzers  
Switzerland  
Tel: +41 (0) 31 750 3030  
Fax: +41 (0) 31 750 3033  
Email: info@ancon.ch  
Visit: www.ancon.ch

## Ancon Building Products GesmbH

Gerspergasse 9/3 Top 1  
A-1210 Vienna  
Austria  
Tel: +43 (0) 1 259 58 62-0  
Fax: +43 (0) 1 259 58 62-40  
Email: info@ancon.at  
Visit: www.ancon.at

## Ancon GmbH

Bartholomäusstrasse 26  
90489 Nuremberg  
Germany  
Tel: +49 (0) 911 955 1234 0  
Fax: +49 (0) 911 955 1234 9  
Email: info@anconbp.de  
Visit: www.anconbp.de

These products are available from:

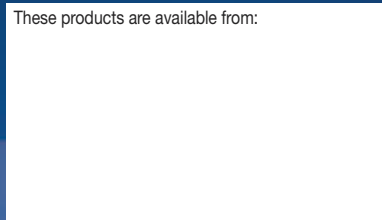

© Ancon Building Products 2008

The construction applications and details provided in this literature are indicative only. In every case, project working details should be entrusted to appropriately qualified and experienced persons.

Whilst every care has been exercised in the preparation of this document to ensure that any advice, recommendations or information is accurate, no liability or responsibility of any kind is accepted in respect of Ancon Building Products.

With a policy of continuous product development Ancon Building Products reserves the right to modify product design and specification without due notice.



ISO 9001: 2000  
FM 12226



ISO 14001: 2004  
EMS 505377